

KENWOOD

INSTRUCTION MANUAL

ENHANCED FEATURES

144/440 MHz FM DUAL BANDER
TH-D7A(G)

KENWOOD CORPORATION

© B62-1359-00 (K)
09 08 07 06 05 04 03 02 01 00



CONTENTS

CHAPTER 1 AUTOMATIC PACKET/ POSITION REPORTING SYSTEM®

OPERATION FLOW	2
CONNECTING WITH A GPS RECEIVER	3
SETTING UTC OFFSET	3
SELECTING DATA BAND	3
SELECTING PACKET TRANSFER RATE	3
RECEIVING APRS DATA	4
ACCESSING RECEIVED APRS DATA	5
PROGRAMMING A CALL SIGN	7
SELECTING YOUR STATION ICON	8
PROGRAMMING POSITION DATA	9
SELECTING A POSITION COMMENT	10
STORING STATUS TEXT	11
PROGRAMMING A GROUP CODE	12
PROGRAMMING A PACKET PATH	13
SELECTING PACKET TRANSMIT METHOD	15
SELECTING PACKET TRANSMIT INTERVAL	16
SELECTING PACKET TRANSMIT DELAY	16
SELECTING STATUS TEXT TRANSMIT RATE	16
RESTRICTING RECEPTION OF APRS DATA	16
PROGRAMMING POSITION AMBIGUITY	17
SELECTING A DISPLAY AREA	17

CHAPTER 2 APRS® MESSAGE

OPERATION FLOW	18
RECEIVING A MESSAGE	19
ACCESSING RECEIVED APRS MESSAGES	20
ENTERING A MESSAGE	21
TRANSMITTING A MESSAGE	22
AUTO ANSWER REPLY	22
PROGRAMMING A GROUP CODE	23

CHAPTER 3 MENU REVISIONS

CHAPTER 4 SUMMARY OF ENHANCEMENT

BAND A & B	26
KEYPAD DIRECT ENTRY	26
TRANSMITTING A 1750 Hz TONE	26
KEY BEEP ON/OFF	26
ADJUSTING VOLUME BALANCE	27
SELECTING DATA BAND	27
DX PACKETCLUSTERS MONITOR	27
DCD SENSE	28

This instruction manual describes only the functions improved or newly designed for the TH-D7A(G) model. For the functions not described in this manual, see the other instruction manual (original).

AUTOMATIC PACKET/ POSITION REPORTING SYSTEM[®]

The Automatic Packet/ Position Reporting System (APRS[®]) is a software program and registered trademark of Bob Bruninga, WB4APR. He has made packet communications much more exciting than before. This program allows you to track mobile stations on a map which you recall on a computer screen. Imagine seeing one mobile station moving on the map which can be scaled from .5 to 2000 miles. You also may be tracked on the computer screen of another station. Stations to be tracked must transmit beacons at certain intervals. To track other stations, you usually need a computer running the APRS, a transceiver, and a TNC. To have them track you, you also need a GPS receiver. It receives signals from the satellites to inform you of your current geographical position. GPS stands for Global Positioning System. The APRS interprets the National Marine Electronics Association (NMEA) data strings coming from the GPS receiver. For further information, consult Internet Web pages relating to the APRS. You may use one of the Internet search engines to find correct URLs.

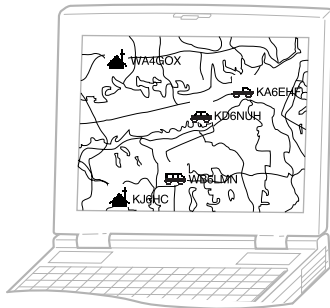

This transceiver includes a TNC and a program for dealing with data formats supported by the APRS. That is, you need no other equipment to transmit, receive, or display APRS packets. You do not need even a GPS receiver if you manually enter position data to transmit. For hams who want to fully enjoy APRS operations, this transceiver has connection ports with a personal computer and a GPS receiver; this manual, however, does not describe APRS operations which require a personal computer.

Using this transceiver, you can transmit a station icon, position data, position comment, and status text. With a GPS receiver, you can also transmit moving speed, moving direction, and altitude data. From any type of station you will receive information listed below:

Station icon	Position data/ Grid square locator
Position comment	Status text
Distance from station	Direction of station

Depending on the types of stations, you will also receive the following information:

Mobile station	Moving direction/ Moving speed/ Altitude
Fixed station	Transmit power/ Height of antenna/ Antenna gain/ Antenna directivity
Fixed station (using compressed APRS data format)	Transmit range
Weather station	Wind direction/ Wind speed/ Temperature/ Rainfall in last hour

OPERATION FLOW

The following flow chart includes only the steps to give APRS a quick try.

➊ Access Menu 2–M to select band A or B as the data band {page 3}. The default is band A.

➋ Press **[TNC]** to enter APRS mode.

- “**tnc**” should appear.

➌ On the data band select the same frequency as other stations in your group.

- You may tune to the frequency of an appropriate digipeater (144.390 MHz in the U.S.A.) {page 13}.

Now you are ready to receive APRS data from other stations. Refer to “RECEIVING APRS DATA” {page 4}. To transmit your APRS data, proceed to step ➍.

➍ Access Menu 2–1 to program your call sign (9 digits max.) {page 7}.

➎ If you have connected a GPS receiver, access Menu 2–2 and select “NMEA” or “NMEA96” {page 3}. The default is “NOT USED”.

➏ Access Menu 2–8 to select your station icon {page 8}.

➐ Access Menu 2–4 to program position data {page 9}.

➑ Access Menu 2–6 to select from 15 position comments {page 10}.

➒ If you want, access Menu 2–9 to enter status text using up to 20 alphanumeric characters {page 11}.

➓ Access Menu 2–C to select the operation method for transmitting APRS data {page 15}.

➑ Press **[BCON]**. If you selected “PTT” in step ➓, then press and release the **PTT** switch. See page 15.

When using a personal computer, press **[TNC]** repeatedly in step ➊ until “PACKET” appears. All further operations should be performed on your computer. For the cable connection with a personal computer, see page 53 on the other instruction manual (original).

Menu Set-up allows you to change various default settings for APRS operations. See the appropriate sections in this chapter.

Note:

- ◆ To distinguish your various stations or nodes, you can have up to 15 Secondary Station IDentifiers (SSIDs); ex. WD6BQD-1 to WD6BQD-15. You always have to put a dash between your call sign and SSID number.
- ◆ If you have blanked the data band by pressing **[DUAL]**, you cannot select APRS mode in step ➊.

CONNECTING WITH A GPS RECEIVER

The **GPS** jack on this transceiver accepts a 2.5 mm (1/10") 3-conductor plug. If necessary, use the supplied cable to modify the cable end of your GPS receiver.

Note: Turn OFF the transceiver power before making the connections.

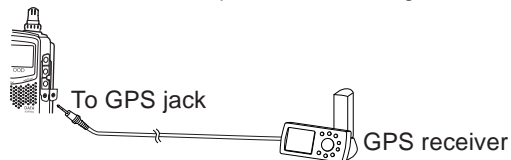

In order to use the connected GPS receiver, access Menu 2-2 (GPS UNIT) to select "NMEA" or "NMEA96". The default is "NOT USED". Select "NMEA96" when using a 9600 bps GPS receiver.

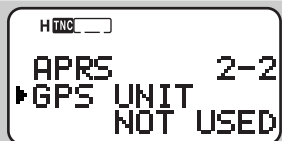

SETTING UTC OFFSET

This transceiver allows you to correct the UTC offset; UTC stands for Universal Time Coordinated. Access Menu 2-O (TIME ZONE) and select the appropriate UTC offset in the range from +12:00 to -12:00 in steps of 30 minutes.

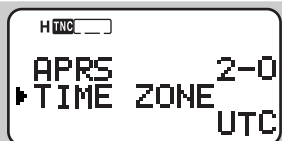

SELECTING DATA BAND

On this transceiver you can select data band for APRS mode independent of the selection (in Menu 1-4-1) for Packet mode. Access Menu 2-M (DATA BAND) and select band A or B as the data band for receiving or transmitting APRS data. The default is band A. "A" indicates the current data band.



Note: In Menu 2-M, the selection switches among A, B, A:TX B:RX, and A:RX B:TX. Select A:TX B:RX or A:RX B:TX if APRS networks which use two separate frequencies become available in the future. "T" appears for the data transmit band and "R" appears for the data receive band.

SELECTING PACKET TRANSFER RATE

The default APRS packet transfer rate set on the built-in TNC is 1200 bps which is the standard among the current APRS networks. If APRS networks which use 9600 bps transfer rate become available in the future, access Menu 2-N (PACKET SPEED) and select "9600 bps". "96" will appear.

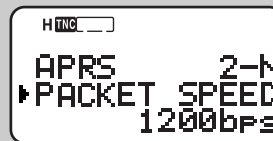

RECEIVING APRS DATA

Each time new APRS data is received, the frequency display is interrupted to show information as below:



- The received APRS data may include information on an object such as a hurricane or tornado. In this case, the name of the object appears instead of a call sign.
- The transceiver restores the frequency display after approximately 10 seconds pass or when you press any key.

Note:

- ◆ When you receive APRS data including an “Emergency” comment, a different format of display from the above will appear and a different beep will sound.
- ◆ When you receive APRS data that you transmitted, the frequency display is not interrupted. “MY POSITION” will appear at the bottom of the display. This could happen when one or more digipeaters {page 13} are used.

If a received packet does not include new (or proper) APRS data, the frequency display is not interrupted. An indicator such as “dP” appears depending on the types of data. See the table.

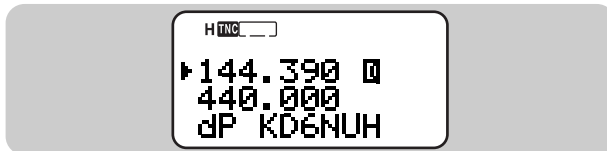

Indicator	Meaning	What is Included?
nP {page 17}	New position	New position comment
nS {page 17}	New status	New status text
dP	Duplicate position	Position comment already received
dS	Duplicate status	Status text already received
>P	Beyond position limit	Data from a station outside the selected range {page 16}
Q ? ¹	Query	Request for sending information
??	Packet that cannot be decoded	

¹ The transceiver automatically transmits the appropriate information in approximately 2 minutes after receiving a request.

Note: The APRS programs for PCs have entry fields for a position comment and status text. The data entered to these two fields are transmitted as separate packets. This transceiver, however, includes both of a position comment and status text in one packet to transmit.

This transceiver beeps each time it receives any type of APRS packet. You may access Menu 2–F (BEEP) to change this setting. The default is “ALL”. The selection in this menu is shared with APRS Message {page 19}.

Selections	New Packet	Duplicate Packet	Invalid Packet
OFF	No beep	No beep	No beep
MINE	This selection is valid only for APRS Message {page 19}.		
ALL NEW	Beep	No beep	No beep
ALL	Beep	Beep	Beep

ACCESSING RECEIVED APRS DATA

This transceiver is capable of receiving and storing APRS data from up to 40 stations in memory. You can select the desired station and access the desired information, by switching the display.

1 Press **[LIST]**.

- The display for selecting a station appears.
- The numbers beside the call signs indicate the order in which data is received. The data received last is assigned 1.

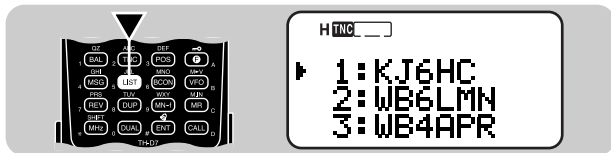

2 Press **[UP]/ [DWN]** to select the desired station.

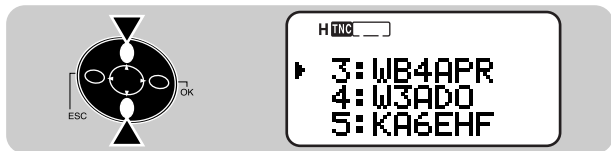

3 Press **[OK]**.

- The display for accessing the desired information appears.

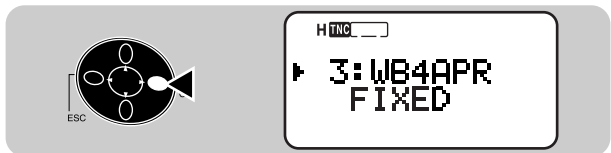

4 Press **[OK]** repeatedly until you can access the desired information.

- The next page shows how displays will be switched.
- You may press **[ESC]** to restore the previous display.

5 Press **[LIST]** twice to restore the frequency display.

You may want to delete all information of the desired station. Press **[A/B]** instead of **[OK]** in step 3 or 4. "DELETE?" appears. Press **[OK]** to delete the information.

To delete the information of all stations, press **[A/B] (1 s)** in step 2. "DELETE ALL?" appears. Press **[OK]**. Then "SURE?" appears. Press **[OK]** again to delete the information.

The types of information accessible in step 4 differ depending on the types of stations. For details, see the next page.

Note:

- ◆ When data from the 41st station is received, the oldest data in memory is replaced by that data.
- ◆ Each time new APRS data is received from the same station, the old data from that station (in memory) is replaced by new data.
- ◆ When APRS data is received with a GPS receiver connected, included position data is sent to the receiver, using the NMEA-0183 \$GPWPL format (or Magellan format). This data is registered in the Waypoint List of the receiver. Access Menu 2-3 (WAYPOINT) and select the number of characters to be input. You can select 6 to 9 digits for NMEA, 6 digits for Magellan, DGPS, or OFF (default). With NMEA 6 digits selected, the right 6 characters of the call sign is used as a name (ex. for KJ6HC-3, J6HC-3). Select DGPS to input differential position data to a DGPS-compatible receiver if it is connected.

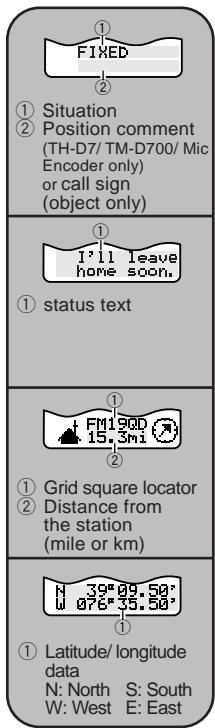
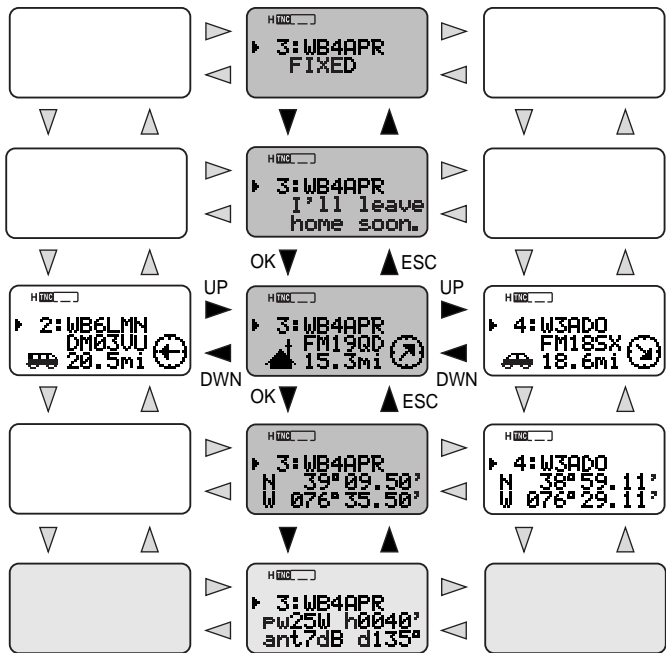

① Situation
② Position comment (TH-D7/ TM-D700/ Mic Encoder only) or call sign (object only)

① status text

① Grid square locator
② Distance from the station (mile or km)

① Latitude/ longitude data
N: North S: South
W: West E: East

Fixed station	Fixed station ¹	Mobile station	Weather station
① Transmit power ② Height of antenna (elevation) ③ Antenna gain ④ Antenna directivity omni: Omnidirectional	① Transmit range (mile or km) ¹ Using compressed APRS data format	① Altitude : Feet M: Meter ② Moving direction ③ Moving speed m: Mile/hour k: km/hour	① Wind direction ② Wind speed m: Mile/hour k: km/hour ③ Temperature F: °F c: °C ④ Amount of rainfall in the past hour (" or mm)

This transceiver is capable of displaying the following 19 icons as station IDs. When icon data other than these is received, the display will show an icon code such as /\$ or \\$.



Some icons may appear with overlay characters as below if the received icon data includes them.



The following icons show the directions of stations relative to your position. For example, “↗” indicates the other station is located at the northeast relative to your position.



0.0 to 9999 miles (or km) are shown for distances from other stations. “xxxxmi” (or “xxxxkm”) is shown for distances over 9999 miles (or km). If you do not change the position data in Menu 2–4 from the default, “---mi” (or “---km”) is shown.

On the TH-D7A(G), the default units for distance and temperature are mile and °F. If necessary, access Menu 2–H (mile/km) and/or Menu 2–I (TEMPERATURE) to change the setting(s).

Note: Some stations transmit APRS data through TNCs connected to GPS receivers. If you receive data from those stations, “GOOD” (satellites tracked) or “LAST” (satellites not tracked) will be shown as the situation, with GLL, GGA, or RMC which designates \$GPGLL, \$GPGGA, or \$GPRMC format.

PROGRAMMING A CALL SIGN

Program your call sign using a maximum of 9 alphanumeric characters; you may include SSID characters. Unless you program a call sign, you cannot transmit APRS data.

- 1 Press **[MENU]** to enter Menu mode.
- 2 Press **[2]**, **[1]** to select “2–1 (MY CALLSIGN)”.
 - The display for entering characters appears; the first digit blinks. The default is “NOCALL”.



- 3 Press **[UP]**/ **[DWN]** to select a character, then press **[OK]**.
 - You can enter 0 to 9, A to Z, and –.
 - The cursor moves to the next digit.
- 4 Repeat step 3 to enter up to 9 digits.
 - Pressing **[OK]** after selecting the 9th digit completes the programming.
 - To complete programming after entering less than 9 digits, press **[OK]** twice.
 - Each press of **[ESC]** causes the cursor to move backward.
 - Pressing **[A/B]** deletes the digit at which the cursor is blinking.
- 5 Press **[MENU]** to exit Menu mode.

You can also use the keypad to enter alphanumeric characters in step 3. For example, each press of **[TNC]** switches entry as A, B, C, then 2. Press **[ENT]** to enter –.

SELECTING YOUR STATION ICON

Select an icon which will be displayed on the monitors of other stations as your ID. You may select an icon depending on your current location.

- 1 Press **[MENU]** to enter Menu mode.
- 2 Press **[2]**, **[8]** to select “2-8 (ICON)”.



- 3 Press **[UP]**/**[DWN]** to select from 15 icons plus “OTHERS”, then press **[OK]**.
 - The following 15 icons are selectable:

	KENWOOD		SSTV		Triangle
	Jogger		Aircraft		Jeep
	Home		Boat		Recreation vehicle
	Portable (tent)		Car		Truck
	Yacht		Motorcycle		Van

- 4 Press **[MENU]** to exit Menu mode.

APRS supports approximately 200 icons. It allows users to select each icon by specifying a combination of two ASCII codes, for example, / and !. One is a symbol code, and the other is a table identification code (either / or \). If you select “OTHERS” in step 3, use the following procedures:

- 4 Press **[UP]**/**[DWN]** to select a symbol code, then press **[OK]**.
- 5 Press **[UP]**/**[DWN]** to select a table identification code, then press **[OK]**.
 - For icons that can include overlay characters, 0 ~ 9 and A ~ Z are also selectable.
- 6 Press **[MENU]** to exit Menu mode.

Note: Because the icon code table is occasionally revised, download the latest icon code table from Mr. Bruninga's Web page (<http://web.usna.navy.mil/~bruninga/aprs.html>). Click on “DOWNLOAD APRS” on its home page, then download APRSnnn.zip from the FTP directory where nnn is a 3-digit number. After uncompressing the zip file, you will find a created README directory. Open and see Symbols.txt under this directory.

PROGRAMMING POSITION DATA

This transceiver has 3 memory channels for storing position data. Program latitude and longitude data for up to 3 locations from which you will often transmit APRS data.

Note: Grid squares were developed to shortly identify locations anywhere on the Earth. The world is first divided into 324 areas (AA ~ RR) called "fields". Each field is then divided into 100 "squares" (00 ~ 99). Each square is further divided into 576 "sub-squares" (AA ~ XX). The world is eventually divided into 18, 662, 400 grids; each grid is expressed with 6 digits.

- 1 Press **[MENU]** to enter Menu mode.
 - You may press **[POS]** instead. Then you can skip step 2.
- 2 Press **[2]**, **[4]** to select "2-4 (MY POSITION)".
 - A channel number blinks.

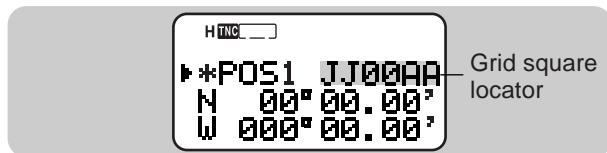

- 3 Press **[UP]/ [DWN]** to select from channels 1 to 3.
 - If you intend to use the current channel after exiting Menu mode, press **[*]**. An asterisk appears at the left of the channel number.
- 4 Press **[OK]**.
 - "N" (or "S") blinks.
- 5 Press **[UP]/ [DWN]** to switch between north latitude (default) and south latitude.

- 6 Press **[OK]**.
 - The degree digits blink.
- 7 Press **[UP]/ [DWN]** to select data for degrees.
- 8 Press **[OK]**.
 - The minute digits blink.
- 9 Repeat steps 7 and 8 to select data for minutes (down to one hundredth digit).

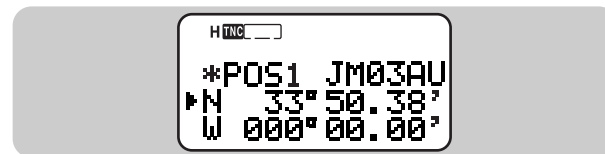

- 10 Press **[UP]/ [DWN]** to switch between west longitude (default) and east longitude.
- 11 Press **[OK]**.
 - The degree digits blink.
- 12 Press **[UP]/ [DWN]** to select data for degrees.
- 13 Press **[OK]**.
 - The minute digits blink.
- 14 Repeat steps 12 and 13 to select data for minutes (down to one hundredth digit).

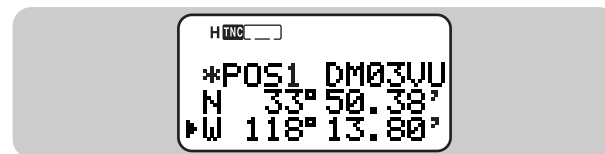

15 As necessary, press **[OK]** then repeat steps 3 to 14 to store in up to 3 memory channels.

16 Press **[MENU]** to exit Menu mode.

To select and set from up to 3 programmed channels, repeat steps 1 to 3. In step 3 press **[UP]/ [DWN]** to select the desired channel, then press **[✕]**.

Note:

- ◆ If you have selected "NMEA" or NMEA96" in Menu 2-2, pressing **[POS]** does not allow you to access the display for entering position data. The position data received via the GPS receiver most lately will be displayed.
- ◆ If using a GPS receiver, you can also copy the measured data to the position entry display for Menu 2-4. Press **[POS]** to display the measured data, then press **[OK]**. A message which asks the channel number appears. Press **[UP]/ [DWN]** to select the channel number, then press **[OK]**.

SELECTING A POSITION COMMENT

The APRS data which you transmit always include one of the 15 predetermined position comments. Select an appropriate comment depending on your situation.

- 1 Press **[MENU]** to enter Menu mode.
- 2 Press **[2], [6]** to select "2-6 (POS COMMENT)".

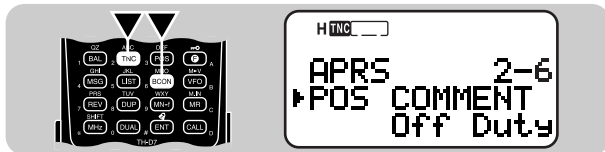

3 Press **[UP]/ [DWN]** to select the desired comment.

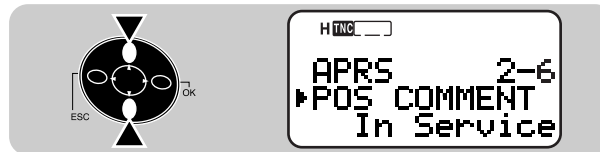

4 Press **[OK]** to complete the setting.

5 Press **[MENU]** to exit Menu mode.

The selectable comments are listed below:

Off Duty (default)	En Route	In Service
Returning	Committed	Special ¹
Priority ¹	Emergency! ²	Custom 0 ~ 6

¹ Selecting these comments will highlight your station on all other APRS computer displays.

² Select this comment only when absolutely necessary. You will activate alarms in all monitoring APRS stations.

Note: Custom 0 ~ 6 selectable in Menu 2-6 are not defined; these are reserved for personal definition.

PROGRAMMING A GROUP CODE

Using a group code relieves you from receiving unwanted packets. The APRS on this transceiver supports the following three types of group codes.

All calls:

Program a 6-digit code that always starts with AP. You will receive all APRS packets which include AP in group codes. It does not matter whether or not the subsequent 4 digits match. The default on this transceiver is APK002; K002 stands for KENWOOD Ver. 2.

Note: APRS packets, which are generated via various methods, include various codes instead of group codes. Using "All calls" allows you to receive packets which include the following codes.

GPS	SYM	QST	CQ	BEACON
ALL	SKYWRN	MAIL	ID	SPCL

Special:

Enter "SPCL". You will receive only APRS packets that include SPCL as a group code. This code is generally programmed by all stations at a special event.

Alternate net:

Program any other code with a maximum of 6 digits. You will receive only APRS packets that include the exact same code. In order to reject other packets, this code should not include characters specified by the above two types.

Note: The display shown in step 1 has a field for entering up to 9 digits (not 6 digits) because of possible future enhancement of the group code system.

1 Access Menu 2-E (UNPROTOCOL), then press [OK].

- The display for entering characters appears; the first digit blinks. The default is APK002 (All calls).



2 Press [UP]/ [DWN] to select a character.

- You can enter 0 to 9, A to Z, and –.

3 Press [OK].

- The cursor moves to the next digit.

4 Repeat steps 2 and 3 to enter up to 6 digits.

- Each press of [ESC] causes the cursor to move backward.
- Pressing [A/B] deletes the digit at which the cursor is blinking.

5 Press [OK].

- If the cursor is blinking over the last digit that you have entered, press [OK] twice.

6 Press [MENU] to exit Menu mode.

You can also use the keypad to enter alphanumeric characters in step 2. For example, each press of [TNC] switches entry as A, B, C, then 2. Press [ENT] to enter –.

PROGRAMMING A PACKET PATH

A packet path specifies how APRS data should be transferred via one or more repeaters. A repeater, which is used for packet transfer, is commonly called a digipeater. This came from a digital repeater. A digipeater is usually located on a mountain top or high building. Unlike a voice repeater, it operates on a simplex frequency. Each volunteer who installs a digipeater programs it either as a WIDE or RELAY type. Generally a WIDE transmits packets over much greater distances than a RELAY.

On this transceiver, you can edit a packet path using a maximum of 32 alphanumeric characters. The default is "RELAY,WIDE" that is one of the common settings. With this setting, packets will be transferred to a RELAY first, then to a WIDE. The APRS supports various methods for specifying a packet path. Some of those methods are described on the next page.

Note:

- ◆ This transceiver is incapable of functioning as a digipeater.
- ◆ To serve for mobile stations who always use the RELAY,WIDE path, most WIDEs also respond to packets addressed to a RELAY.

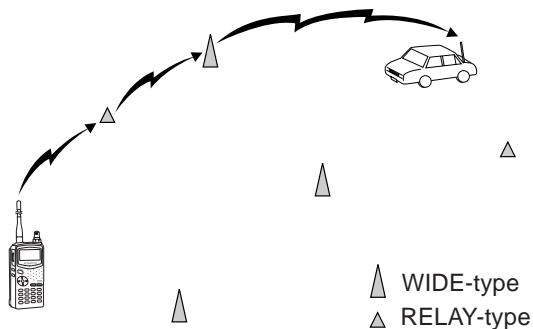

- 1 Access Menu 2-B (PACKET PATH), then press **[OK]**.
 - The display for entering characters appears; the first digit blinks.



- 2 Press **[UP]/ [DWN]** to select a character.
 - You can enter 0 to 9, A to Z, , (comma), and -.
- 3 Press **[OK]**.
 - The cursor moves to the next digit.
- 4 Repeat steps 2 and 3 to enter up to 32 digits.
 - Use a comma to separate each path segment.
 - Pressing **[OK]** after selecting the 32nd digit completes the programming.
 - To complete programming after entering less than 32 digits, press **[OK]** twice.
 - Each press of **[ESC]** causes the cursor to move backward.
 - Pressing **[A/B]** deletes the digit at which the cursor is blinking.
- 5 Press **[MENU]** to exit Menu mode.

You can also use the keypad to enter alphanumeric characters in step 2. For example, each press of **[TNC]** switches entry as A, B, C, then 2. Press **[ENT]** to switch between , and -.

Let us describe five basic methods for editing a packet path. Methods 3 to 5 are supported only by advanced APRS networks.

Method 1 (Specific Path):

Program the call signs of one or more digipeaters in the sequence of transfer relay; ex. "KD6ZZV,KF6RJZ".

Method 2 (Generic Path):

Program RELAY and/or WIDE; ex. "RELAY,WIDE" (or simply "R,W"). In this example, your APRS packet is transferred to any RELAY digipeater near your position first, then to any WIDE digipeater. You can also program more than one WIDE. If you enter "WIDE,WIDE" for example, your APRS packet will be transferred to any WIDE near your position first, then to another WIDE.

Method 3 (WIDEN-N Path):

Program WIDEN-N, where both Ns indicate the number of WIDE digipeaters to be used for relay. If you enter "WIDE3-3" (or simply "W3") for example, your APRS packet will be relayed by three WIDEs in any direction.

Method 4 (TRACEN-N Path):

The operation is the same as WIDEN-N except that digipeaters add their call signs to your packet before forwarding. You may program "TRACE3-3" (or simply "T3") for example.

Method 5 (SSID Path):

Program a single number 1 to 15. You can easily specify the number of digipeaters that will be used for relay. You can also specify which directions of digipeaters relative to your position will be used. See the table.

Parameter	Number of digipeaters	Direction
1	1	All
2	2	All
3	3	All
4	4	All
5	5	All
6	6	All
7	7	All
8	2 (or more) ¹	North
9	2 (or more) ¹	South
10	2 (or more) ¹	East
11	2 (or more) ¹	West
12	Many ²	North
13	Many ²	South
14	Many ²	East
15	Many ²	West

¹ The first digipeater which receives your APRS data specifies the entire route to the destination before forwarding; often 2 digipeaters are used in total.

² The digipeater which receives your APRS data specifies the call sign of the next digipeater before forwarding. This is repeated until your APRS data reaches the destination.

SELECTING PACKET TRANSMIT METHOD

Select the operation method for transmitting APRS data. The table concludes how operations differ depending on the selection:

- 1 Access Menu 2-C (DATA TX), then press **[OK]**.

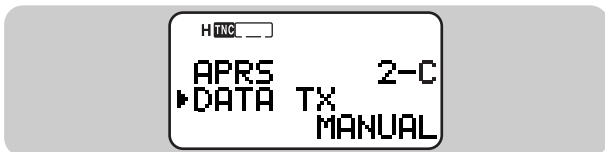

- 2 Press **[UP]**/ **[DWN]** to select Manual (default), PTT, or Auto.



- 3 Press **[OK]** to complete the setting.
- 4 Press **[MENU]** to exit Menu mode.

Note: When using a GPS receiver, this transceiver transmits APRS data for the first time after any NMEA data is received.

MANUAL	Each press of [BCON] transmits the APRS data.
PTT	<ol style="list-style-type: none"> 1 Press [BCON] to switch the function ON. <ul style="list-style-type: none"> • “BCON” appears and blinks. 2 Press and hold the PTT switch, then speak into the microphone. 3 Release the PTT switch. <ul style="list-style-type: none"> • Releasing the switch transmits the APRS data. • You cannot retransmit the APRS data unless the time selected in Menu 2-D (TX INTERVAL) passes. Wait until “BCON” starts blinking to indicate transmitting is ready. 4 To switch the function OFF, press [BCON] again.
AUTO	<ol style="list-style-type: none"> 1 Press [BCON] to switch the function ON. <ul style="list-style-type: none"> • “BCON” appears. • Switching the function ON transmits the APRS data once. After that, APRS data is automatically transmitted at intervals of the period selected in Menu 2-D (TX INTERVAL). 2 To switch the function OFF, press [BCON] again.

SELECTING PACKET TRANSMIT INTERVAL

You can change the interval for automatically transmitting APRS data. Access Menu 2-D (TX INTERVAL) and select 0.2, 0.5, 1, 2, 3, 5, 10, 20, or 30 minutes. The default is 5 minutes.



Note:

- ◆ With "AUTO" in Menu 2-C and Beacon ON, pressing [OK] to complete the setting causes the APRS data to be immediately transmitted. After that, APRS data is transmitted at intervals of the selected period.
- ◆ While signals are present, APRS data is not transmitted after the interval. Approximately 2 seconds after signals drop, transmitting is executed.

SELECTING PACKET TRANSMIT DELAY

If necessary, adjust the time delay between keying up of the transmitter and the start of APRS data to the transmitter. Increase this delay, for example, when recipients miss the initial part of your packets and thus fail to decode the data. Access Menu 2-P (TX DELAY) and select 100, 200, 300, 400, 500, 750, or 1000 msec. The default is 500 msec.



SELECTING STATUS TEXT TRANSMIT RATE

A long status text string can double the size and length of the APRS packet. Access Menu 2-A and specify how frequently status text is included in APRS packets to be transmitted. The selectable range is 1/1 to 1/8 and OFF (default). If you select 1/3 for example, status text is included in your packets once every 3 times; accordingly stations who receive your packets will see your status text once every 3 times.

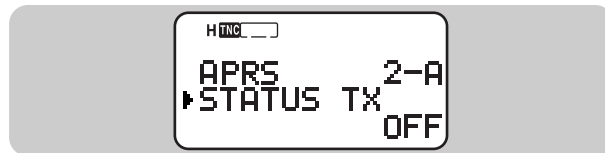

RESTRICTING RECEPTION OF APRS DATA

If APRS is popular in your country, you may receive too many APRS packets for a short period. If this disturbs your APRS activities, specify a distance from your location. You will not receive APRS data from stations beyond this distance. Access Menu 2-7 (POS LIMIT) and select the range from 10 to 2500 in steps of 10, plus OFF (default). The unit is mile or kilometer depending on the selection in Menu 2-H (mile/km) {page 7}.

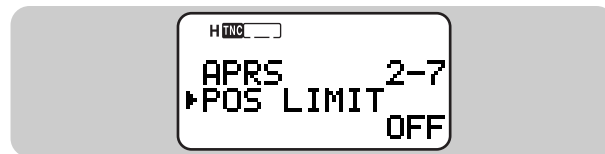

PROGRAMMING POSITION AMBIGUITY

There may be cases where you do not know or do not want to report your precise locations. For position data, you can select the number of digits not to be included in your packets. Access Menu 2-5 (POS AMBIGU) and select 1 to 4, or OFF (default). The table shows how the digits will be cleared on a recipient.



OFF	1	2	3	4
33° 50.38'	33° 50.3 '	33° 50. '	33° 5 . '	33° . '
118° 13.80'	118° 13.8 '	118° 13. '	118° 1 . '	118° . '

SELECTING A DISPLAY AREA

Each time new APRS data is received, the frequency display is interrupted. If this interruption annoys you too much, access Menu 2-G (DISPLAY AREA) to select "ONE LINE". The transceiver then will not exit the frequency display when receiving new data. It will use the bottom of the frequency display to show an indicator (nP or nS) and a call sign; "nP" and "nS" designate New Position and New Status respectively {page 4}. The default is "ENTIRE DISP".

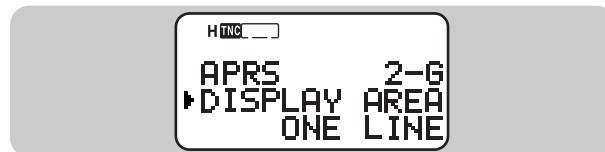

APRS[®] MESSAGE

The APRS[®] supports a function for transmitting and receiving a message independent of position reports. You can transmit a message to a single station only or a bulletin to all other stations in your group. If you specify a station, the entered message is transmitted up to 5 times until an acknowledgment is returned.

Each message which you transmit can consist of up to 45 alphanumeric characters. A maximum of 16 incoming or outgoing messages can be held in the message memory.

OPERATION FLOW

The following steps should guide you to a good start of APRS Message operation.

① Press **[TNC]** to switch ON the TNC.

- "TNC []" appears.

② Access Menu 2-M to select band A or B as the data band {page 3}.

③ On the data band select the same frequency as other stations in your group.

- You may tune to the frequency of an appropriate digipeater (144.390 MHz in the U.S.A.) {page 13}.

④ Access Menu 2-1 to program your call sign (9 digits max.) {page 7}.

Now you are ready to receive a message from other stations. Refer to "RECEIVING A MESSAGE" {page 19}. To transmit a message, proceed to step ⑤.

⑤ If necessary, access Menu 2-B to program a packet path {page 13}.

⑥ Enter a message (or bulletin) using up to 45 alphanumeric characters {page 21}.

Completing step ⑥ causes the transceiver to automatically transmit the message (or bulletin). When you send a message (not a bulletin), an acknowledgment should be returned; "ack0 ~ 9 (or A ~ Z)" appears.

RECEIVING A MESSAGE

Each time a proper message is received, the frequency display is interrupted to show information as below:



- The display shows only the first 24 characters of the message.
- The transceiver restores the frequency display after approximately 10 seconds pass or when you press any key.
- “” appears and stays at the bottom left of the display until you use the List function {page 20}.

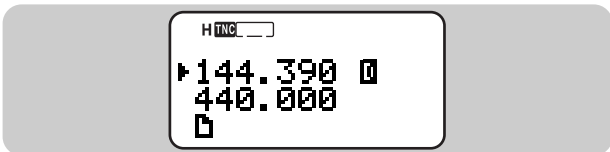

The following indicators appear depending on types of received messages:

 # ¹	Message addressed to you
G1~6 ²	Message addressed to your group {page 23}
B# ¹	Bulletin
!	Report by the National Weather Service
*	Acknowledgment to your message

¹ # designates an ASCII character used for indicating the sequence of message (or bulletin) packets; ex. 0 to 9.

² 1 to 6 designates a group identification number {page 23}.

When a duplicate message from the same station is received, an error beep sounds. In addition, “dM” (indicator) and a call sign appear on the display.

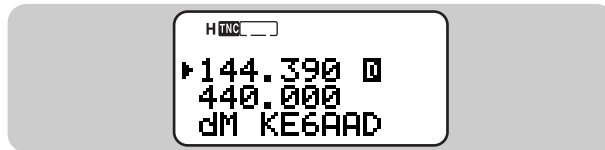

- When a message to other stations is received, “oM” appears as an indicator.
- When a new message not addressed to only you is received with “ONE LINE” selected in Menu 2–G {page 17}, “nM” appears as an indicator.

This transceiver beeps each time it receives any type of APRS packet. You may access Menu 2–F (BEEP) to change this setting. The default is “ALL”.

Selections	New Packet	Duplicate Packet	Invalid Packet
OFF	No beep	No beep	No beep
MINE	Beeps only when receiving a message addressed to you.		
ALL NEW	Beep	No beep	No beep
ALL	Beep	Beep	Beep

Note:

- ◆ When you receive a message that you transmitted, the frequency display is not interrupted. “MY MESSAGE” will appear at the bottom of the display. This could happen when one or more digipeaters {page 13} are used.
- ◆ This transceiver allows you to receive a message also when the SSID does not match. However, it will not return an acknowledgment.
- ◆ When a message addressed to you is received, the transceiver display and keypad are illuminated. If you do not press any key in approximately 5 seconds, the light goes off.

ACCESSING RECEIVED APRS MESSAGES

This transceiver is capable of storing a maximum of 16 messages in memory. You can access the desired message by switching the display.

- 1 Press **[MSG]**.
- 2 Press **[UP]**/**[DWN]** to select "LIST".



- 3 Press **[OK]**.
- 4 Press **[UP]**/**[DWN]** to select the desired station.
 - Press **[OK]** to see the 25th and subsequent digits of the message.
 - "4" indicates the end of the message.
 - Pressing **[A/B]** (1 s) deletes all the messages.
- 5 Press **[ESC]** twice to restore the frequency display.

Pressing **[MSG]** in step 4 allows you to enter a message to be returned to the station. You can skip steps 1 to 6 in "ENTERING A MESSAGE" {page 21}.

Note:

- ◆ The dedicated memory is used for storing both received messages and messages for transmitting. Receiving a new message when the memory is full causes the oldest message to be deleted. A message not yet transmitted 5 times may be unexpectedly deleted. If "4" stays at the bottom left of the display when memory is full, a new message does not replace the oldest message. This transceiver returns a reject command and shows "rM" and a call sign at the bottom of the display.
- ◆ A message already transmitted can be easily sent to the same station. Select the message in step 4 and press **[MSG]**. The call sign and message are copied to the recalled entry display {page 21}.

Besides the call sign and message, the display will show the following types of information:



① Message Type	
☐# ¹	Message addressed to you
G1~6 ²	Message addressed to your group
B# ¹	Bulletin
!	Report by the National Weather Service
② RX or TX?	
<	Received message (or bulletin)
> ³	Message (or bulletin) for transmitting
③ Status	
5~1 ³	Remaining number of times for transmitting the message (or bulletin).
* ³	Message for which an acknowledgment was returned
. ³	Message (or bulletin) transmitted 5 times (For a message, an acknowledgment was not returned.)

¹ # designates an ASCII character used for indicating the sequence of message (or bulletin) packets; ex. 0 to 9. For outgoing messages or bulletins, only sequence numbers appear.

² 1 to 6 designates a group identification number {page 23}.

³ These indicators appear for outgoing messages {page 22}.

ENTERING A MESSAGE

To transmit a message, first enter the call sign of the target station. To transmit a bulletin, enter “BLN#” instead; where # must be 0 to 9 or A to Z. When the length of your bulletin exceeds 45 digits, you may transmit more than one packet to send the entire bulletin. Use # to indicate the sequence of the bulletin portions. For example, enter “BLN0” (or “BLNA”) to send the first packet, then “BLN1” (or “BLNB”) to send the second packet.

- 1 Press **[MSG]**.
- 2 Press **[UP]/ [DWN]** to select “INPUT”.



- 3 Press **[OK]**.
 - The display for entering a call sign appears; the first digit blinks.



- 4 Press **[UP]/ [DWN]** to select a character.
 - You can enter 0 to 9, A to Z, and –.
 - You may use the keypad. For example, each press of **[TNC]** switches entry as A, B, C, then 2. Press **[ENT]** to enter –.

- 5 Press **[OK]**.
 - The cursor moves to the next digit.
- 6 Repeat steps 4 and 5 to enter up to 9 digits.
 - Pressing **[OK]** after selecting the 9th digit causes the cursor to move to the start of the next field.



- To complete programming the call sign after entering less than 9 digits, press **[OK]** twice.
 - Each press of **[ESC]** causes the cursor to move backward.
 - Pressing **[A/B]** deletes the digit at which the cursor is blinking.
- 7 Press **[UP]/ [DWN]**, then **[OK]** to select the first digit of a message (or bulletin).
 - You may use the keypad. For example, each press of **[TNC]** switches entry as a, b, c, 2, A, B, then C. Press **[ENT]** to switch among the special ASCII characters.
 - 8 Repeat step 7 to enter a message (or bulletin) with up to 45 digits.
 - To complete programming after entering less than 45 digits, press **[OK]** twice.
 - Completing step 8 causes the transceiver to automatically transmit the message (or bulletin). If you send a message to a single station, an acknowledgment should be returned; “ack 0 ~ 9 (or A ~ Z)” appears.

Note: You may enter % as the initial character of the message. Some APRS systems are capable of announcing characters one by one when receiving a message which starts with %. Those systems include TM-D700s with VS-3 units.

TRANSMITTING A MESSAGE

When entry of a message (or bulletin) is completed, this transceiver automatically starts transmitting it at intervals of 1 minute. With a message entered, the transceiver repeats transmitting up to 5 times until an acknowledgment is returned. With a bulletin entered, the transceiver always repeats transmitting 5 times; an acknowledgment is not returned.

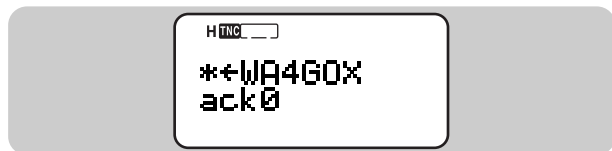

The table given on page 20 also shows indicators that appear for outgoing messages (or bulletins). You can also manually transmit all of those regardless of the 5-minute timer.

- 1 Press **[MSG]**.
- 2 Press **[UP]/ [DWN]** to select “TRANSMIT”.



- 3 Press **[OK]** to start transmitting.
 - After transmission, the frequency display is restored.

AUTO ANSWER REPLY

This transceiver is capable of automatically returning a programmed message when any message is received.

- 1 Access Menu 2–J (AUTO REPLY), then press **[OK]**.



- 2 Press **[UP]/ [DWN]** to select “ON”, then press **[OK]**.
- 3 Access Menu 2–K (REPLY MSG), then press **[OK]**.
 - The display for entering a message appears; the first digit blinks.

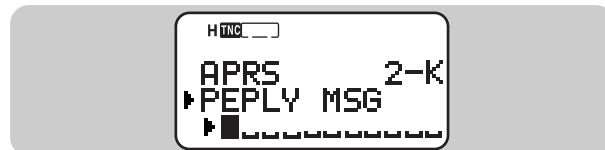

- 4 Press **[UP]/ [DWN]** to select a character, then press **[OK]**.
 - The cursor moves to the next digit.
 - You can enter alphanumeric characters plus special ASCII characters.
 - You may use the keypad. For example, each press of **[TNC]** switches entry as a, b, c, 2, A, B, then C. Press **[ENT]** to switch among the special ASCII characters.
- 5 Repeat step 4 to enter a message with up to 45 digits.
 - To complete programming after entering less than 45 digits, press **[OK]** twice.

PROGRAMMING A GROUP CODE

Use a message group code to exchange messages only among your group members. With one or more message group codes programmed, you will receive messages that include the same group code(s), besides messages addressed to you. You can program any desired code using up to 9 alphanumeric characters. You can also program up to 6 codes at the same time. If you program 3 message group codes, for example, you will receive all messages that include one of the 3 codes.

1 Access Menu 2-L (MSG GROUP), then press **[OK]**.

- The display for entering one or more group codes appears; the first digit blinks.



2 Press **[UP]**/ **[DWN]** to select a character.

- You can enter 0 to 9, A to Z, , (comma), -, and *.

3 Press **[OK]**.

- The cursor moves to the next digit.

4 Repeat steps 2 and 3 to enter up to 6 codes.

- Use a comma to separate each code.
- You can enter up to 45 alphanumeric characters in total.
- To complete programming after entering less than 45 digits, press **[OK]** twice.

5 Press **[MNU]** to exit Menu mode.

You can also use the keypad to enter alphanumeric characters in step 2. For example, each press of **[TNC]** switches entry as A, B, C, then 2. Press **[ENT]** to enter , (comma), -, or *.

You may use * as a wildcard character. If you program ABC* for example, you will receive all messages including group codes which start with ABC.

When a message which matches one of the group codes is received, **[#]** and G1 ~ 6 appear alternately {page 19}. 1 to 6 after G designates a group identification number. Let us assume that you have not changed the default group codes; ALL, QST, CQ, KWD. If a message with "QST" is received, G2 appears to indicate the 2nd code. If a message with "KWD" is received, G4 appears to indicate the 4th code.

In order to include a message group code in your outgoing packet, enter a group code in place of a call sign {page 21}, using up to 9 characters.

MENU REVISIONS

On a TH-D7A(G), the menu configuration under TNC (1–4–), AUX (1–5–), and APRS (2–) has been revised as below. For the reference pages in parentheses, see the other instruction manual (original).

Level 1		Level 2		Level 3		Selections	Default	Ref. page
1	RADIO	4	TNC	1	Packet band	See reference page.	Band A	27
				2	DCD sense	<input type="checkbox"/> or <input type="checkbox"/> band/ Both bands/ Ignore DCD	<input type="checkbox"/> or <input type="checkbox"/> band	28
		5	AUX	1	Automatic Repeater Offset	ON/ OFF	ON	(23)
				2	Scan Resume	Time-Operated/ Carrier-Operated/ Seek	Time-Operated	(34)
				3	Key Beep	ON/ OFF	ON	26
				4	Tuning Enable	ON/ OFF	OFF	(50)
				5	TX Inhibit	ON/ OFF	OFF	(51)
				6	Advanced Intercept Point	ON/ OFF	OFF	(51)
				7	Call Key Function	Call/ 1750 Hz TX	Call	26
8	TX Hold, 1750 Hz	ON/ OFF	OFF	26				
9	Reset	Partial (VFO)/ Full/ No	—	(32)				
2	APRS	1	My call sign	See reference page.	—	7		
		2	GPS receiver	Not used/ NMEA/ NMEA96	Not used	3		
		3	Waypoint	See reference page.	OFF	5		
		4	My position	See reference page.	—	9		
		5	Position Ambiguity	1/ 2/ 3/ 4 digits/ OFF	OFF	17		

Level 1		Level 2		Selections	Default	Ref. page
2	APRS	6	Position comment	See reference page.	Off Duty	10
		7	Reception restriction distance	10 ~ 2500 in steps of 10/ OFF	OFF	16
		8	Station icon	See reference page.	—	8
		9	Status text	See reference page.	—	11
		A	Status text transmit rate	See reference page.	OFF	16
		B	Packet path	See reference page.	RELAY,WIDE	13
		C	Packet transmit method	Manual/ PTT/ Auto	Manual	15
		D	Packet transmit interval	0.2/ 0.5/ 1/ 2/ 3/ 5/ 10/ 20/ 30 minutes	5 minutes	16
		E	Group code	See reference page.	APK002	12
		F	Beep	Mine/ All new/ All/ OFF	All	4, 19
		G	Display area	Entire display/ One Line	Entire display	17
		H	Unit for distance	Mile/ Kilometer	Mile	7
		I	Unit for temperature	°F/ °C	°F	7
		J	Auto Answer Reply	ON/ OFF	OFF	22
		K	Reply message	See reference page.	—	22
		L	Message group	See reference page.	ALL,QST, CQ,KWD	23
		M	Data band	See reference page.	A	3
N	Packet transfer rate	1200/ 9600 bps	1200 bps	3		
O	Time Zone	See reference page.	—	3		
P	Packet transmit delay	100/ 200/ 300/ 400/ 500/ 750/ 1000 msec.	500 msec.	16		

SUMMARY OF ENHANCEMENT

Besides APRS functions, the TH-D7A(G) has several functions improved or newly added, as below. You may refer to the given pages to identify differences from a TH-D7A.

BAND A & B

Without switching ON the TNC, you will not see “**H**” which indicates the current data band. This modification has been made because the TH-D7A(G) allows you to select a different band (A or B) as the data band between Packet and APRS operations. Refer to page 12 on the other instruction manual (original).

KEYPAD DIRECT ENTRY

When programming a memory channel name, Power-ON message, status message, or APRS message, each press of [**TNC**], for example, switches entry as a, b, c, 2, A, B, then C. Refer to page 15 on the other instruction manual (original).

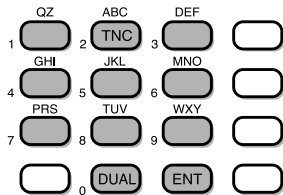

TRANSMITTING A 1750 Hz TONE

The TH-D7A(G) allows you to program [**CALL**] as a key for transmitting a 1750 Hz (burst) tone. Access Menu 1-5-7 (CALL KEY) and select “1750 Hz”. To transmit a 1750 Hz tone, press [**CALL**] without pressing the PTT switch. Release [**CALL**] to quit transmitting.



In order to cause the transceiver to remain in the transmit mode for 2 seconds after transmitting a 1750 Hz tone, access Menu 1-5-8 (TX HOLD,1750), then select “ON”.

KEY BEEP ON/OFF

If you are distracted by beeps generated when pressing a key on the keypad, switch OFF the Key Beep. The transceiver will beep only when it receives appropriate APRS or DX cluster data. Access Menu 1-5-3 (KEY BEEP) and select “OFF”. The default is “ON”. Refer to page 47 on the other instruction manual (original).



ADJUSTING VOLUME BALANCE

The TH-D7A(G) allows you to adjust volume balance even after blanking one band. Refer to page 48 on the other instruction manual (original).

SELECTING DATA BAND

When accessing a PACSAT, access Menu 1-4-1 (PACKET BAND) and select "A:TX B:RX" (or "A:RX B:TX"). "T" appears for the data transmit band and "R" appears for the data receive band.



PACSATs refer to satellites designed and launched for digital communications using the AX.25 protocol. The PACSATs usually receive (uplink) on VHF and transmit (downlink) on UHF. For further information, consult Internet Web pages relating to the PACSATs. You may use one of the Internet search engines to find those Web pages.

Note: If you have blanked the data band by pressing [DUAL], pressing [TNC] does not allow you to select Packet mode.

DX PACKETCLUSTERS MONITOR

If the common transfer rate in your local PacketCluster network is 9600 bps, access Menu 2-N (PACKET SPEED) and select "9600 bps". Refer to page 56 on the other instruction manual (original).



When new DX cluster data is received with "ONE LINE" selected in Menu 2-G {page 17}, "nD" appears as an indicator.

DCD SENSE

The TH-D7A(G) provides three methods for inhibiting the built-in TNC from transmitting. Access Menu 1–4–2 (DCD SENSE) and select one of the methods. The default is “**A OR B BAND**”. Refer to page 55 on the other instruction manual (original). The tables below conclude when the TNC is allowed to transmit, depending on the selection.

Menu 1–4–2	A or B Selected for Data Band
A OR B BAND	Does not transmit when signals are present on the data band. Select this method when mainly performing data communications.
BOTH BANDS	Does not transmit when signals are present on band A or B. Select this method when performing voice communications on the main band, and data communications on the sub band.
IGNORE DCD	Transmits even when signals are present on the data band. Select this method only when the TNC often fails to transmit because of constant data reception.

Menu 1–4–2	A:TX B:RX or A:RX B:TX Selected for Data Band
A OR B BAND	Does not transmit when signals are present on the data TX band. Select this method when performing data communications via a PACSAT or ordinary cross-band data communications.
BOTH BANDS	Does not transmit when signals are present on the data RX or TX band. Select this method when performing ordinary cross-band data communications.
IGNORE DCD	Transmits even when signals are present on the data RX or TX band. Select this method when performing data communications via a PACSAT and only when necessary.

Note: When in APRS mode, the TNC functions exactly as described in the tables. The TNC, however, does not function as described in the shaded sections when in Packet mode or KISS mode; it functions as below. Avoid using the shaded configurations when in one of these modes.

Packet mode:

The TNC fails to receive an acknowledgment after transmitting. It then makes retries and unexpectedly disconnects the linkage.

KISS mode:

The TNC transmits when no signals are present on the data band or data RX band.